

Republic offers a complete line of regenerative blowers for high vacuum or compressed air applications in both horizontal and vertical mounted positions. TEFC motors are rated for 50/60 Hz operation and are cUL, UL, and CE certified. The impeller is directly connected to the motor shaft, providing powerful air force without undue friction. The bearings are outside the compression chamber, ensuring maximum operational reliability under high differential pressure. This low-maintenance, oil-free design provides continuous, dependable service to our customers.

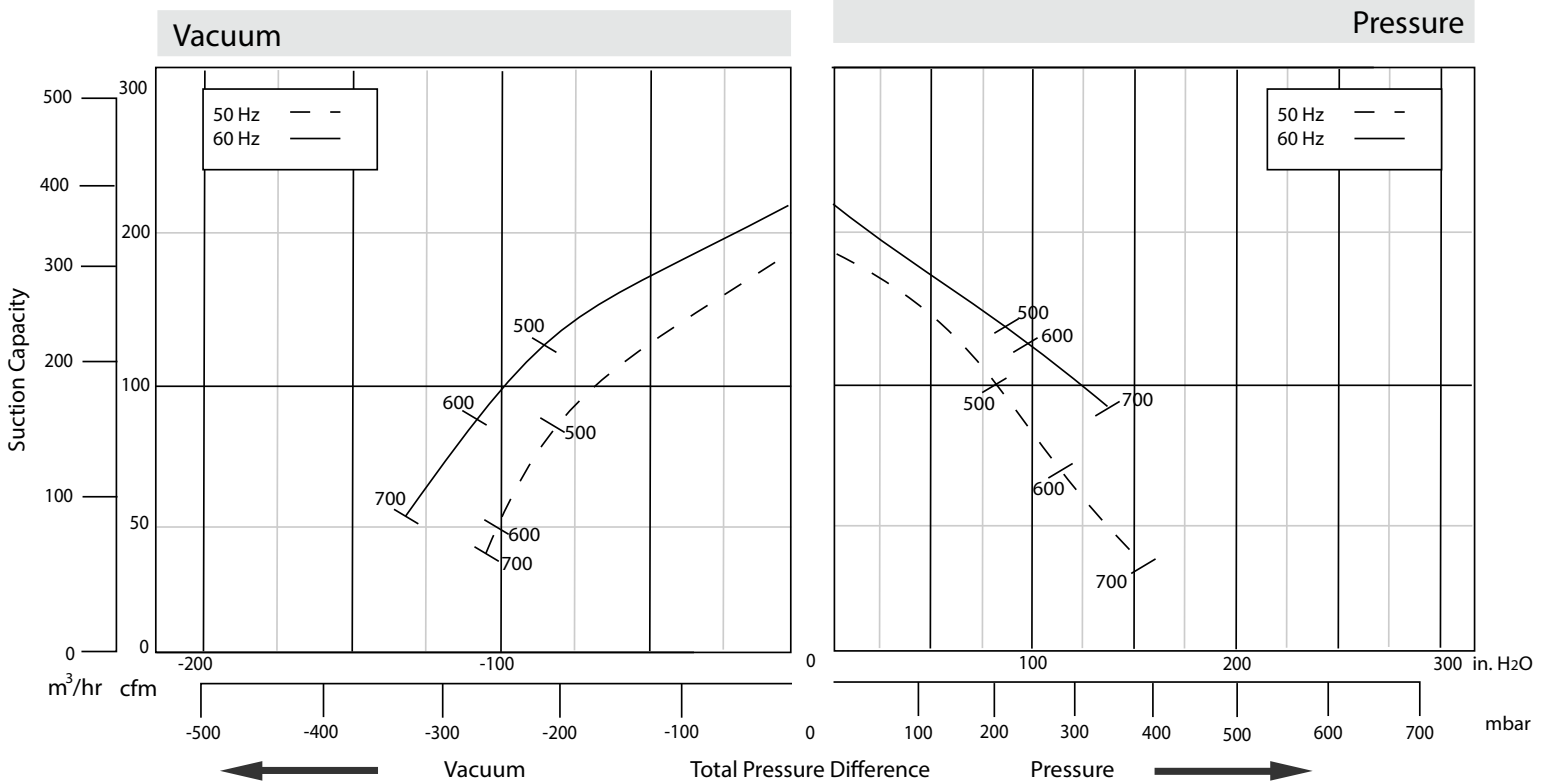

PERFORMANCE



Model	Phase	Frequency (Hz)	Air flow (CFM/m ³ /hr)	Rated Vacuum (in. H ₂ O/mbar)	Rated Pressure (in. H ₂ O/mbar)	Motor (HP/kW)	Voltage (V)	Current (A)	Sound Level (dB)	Weight (lb/kg)
HRB 500	3	50	184/313	76/189	76/189	3.0/2.2	200-240 Δ/345-415 Y	9.7 Δ/5.6 Y	76	68/34
		60	212/360	76/189	76/189	3.4/2.5	220-275 Δ/380-480 Y	10.3 Δ/6.0 Y		
HRB 600	3	50	184/313	104/259	108/269	4.0/3.0	200-240 Δ/345-415 Y	12.5 Δ/7.2 Y	78	77/39
		60	212/360	96/239	92/229	4.6/3.4	220-275 Δ/380-480 Y	12.6 Δ/7.3 Y		
HRB 700	3	50	184/313	116/289	145/361	5.4/4.0	200-240 Δ/345-415 Y	9.5 Δ/5.2 Y	78	85/43
		60	212/360	128/319	124/309	6.2/4.6	220-275 Δ/380-480 Y	9.5 Δ/5.2 Y		

The performance curves are based on air at a temperature of 59 °F and an atmospheric pressure of 29.91 inch Hg with a tolerance of +/-10%. The total pressure differences are valid for inlet and ambient temperatures up to 77 °F. Suction capacity relates to inlet conditions. Pressure capacity relates to atmospheric conditions. For other conditions please contact Republic. Three phase motor tolerances are +/-10% for fixed voltage motors and +/-5% for voltage range motors. Single phase machines are designed with a +/-5% tolerance. The frequency tolerance is +/-2% maximum.

APPROXIMATE DIMENSIONS

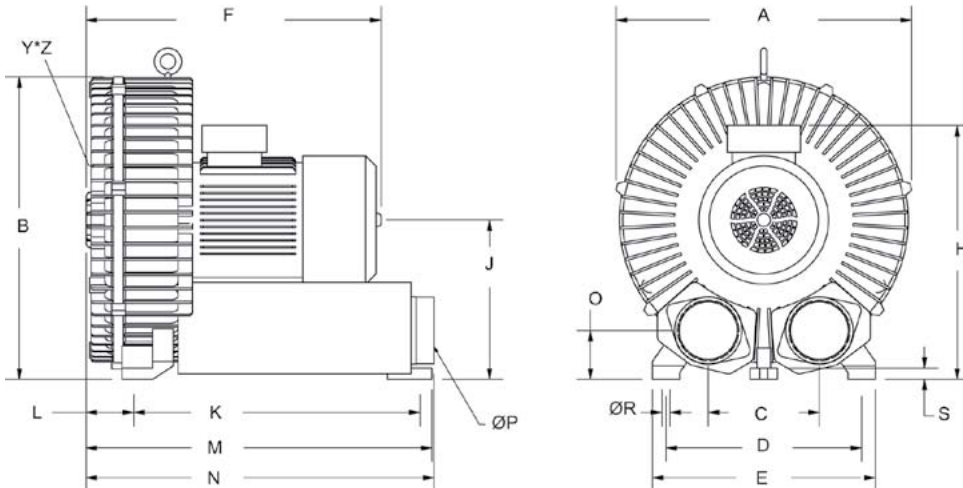

Model	Unit	A	B	C	D	E	F	H	J	K	M	N	O	ØP	ØR	S	Y*Z
HRB 500	in	15.04	15.28	4.92	11.42	12.80	15.44	13.27	7.76	5.51	4.06	4.29	2.13	2.00	0.59	0.18	M8
	mm	382	388	125	290	325	392	337	197	140	103	109	54				
HRB 600	in	15.04	15.28	4.92	11.42	12.80	6.69	13.27	7.76	5.51	4.06	4.29	2.13	2.00	0.59	0.18	M8
	mm	382	388	125	290	325	424	337	197	140	103	109	54				
HRB 700	in	15.04	15.28	4.92	11.42	12.80	18.06	18.06	7.76	5.51	4.01	4.29	2.13	2.00	0.59	0.18	M8
	mm	382	388	125	290	325	459	337	197	140	102	109	54				

Available Options

All Republic Regenerative Blowers are available in pre-assembled kits for either pressure or vacuum applications. These kits include an inlet filter, gauge and relief valve, and are factory tested prior to shipment. Optional items for these kits include check valve, and tube adaptor; washdown motors, explosion proof motors, or other specialty motors; noise enclosures; and control panels such as VFD's, PLC's, or starter panels.

VACUUM KIT

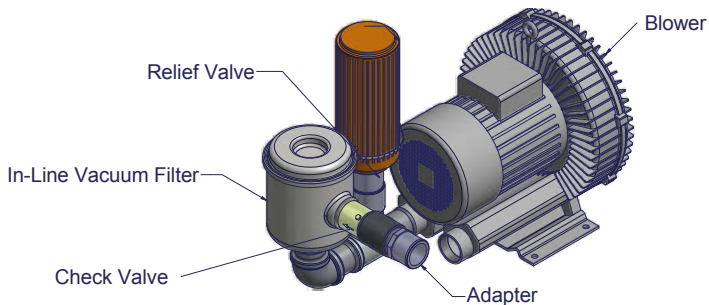

PRESSURE KIT

