

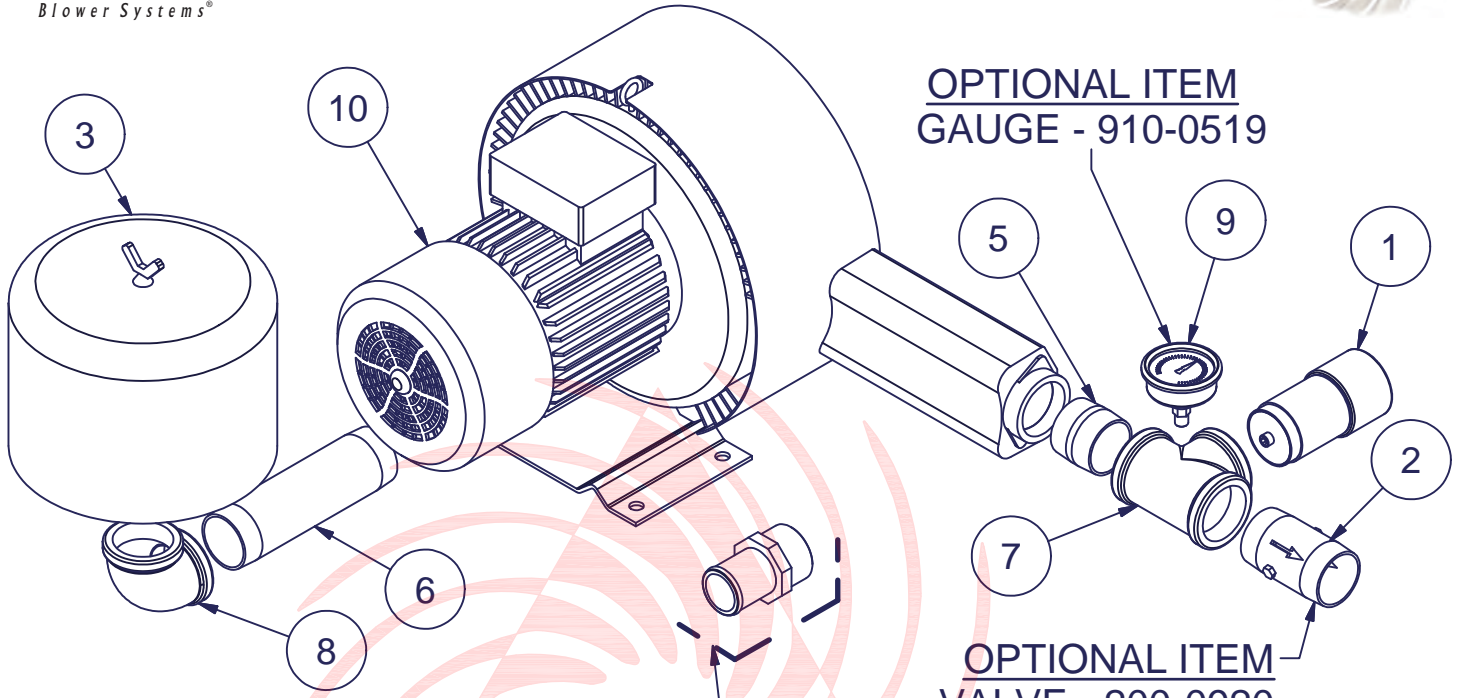

REPUBLIC
Blower Systems®



OPTIONAL ITEM
GAUGE - 910-0519

OPTIONAL ITEM
VALVE - 200-0920

OPTIONAL ITEM
ADAPTER - 900-0006

10	HRB602	1	Republic Sales Regen Blower
9	910-0519	1	Liquid Filled Gauge (Pressure) Regens
8	910-0204	1	Elbow 2.0 NPT X 90 DEG (Black)
7	910-0201	1	Tee 2.0 NPT (Black)
6	900-0495	1	Nipple 2" NPT X 8" LG (Black)
5	900-0490	1	Nipple 2" NPT x 2" LG (Black)
4	900-0006	1	Adapter 2" NPT x 2" OD
3	340-2215	1	Filter
2	200-0920	1	Valve
1	200-0516	1	2" Vacuum Relief Valve
ITEM	PART NUMBER	QTY	DESCRIPTION
Bill of Materials			

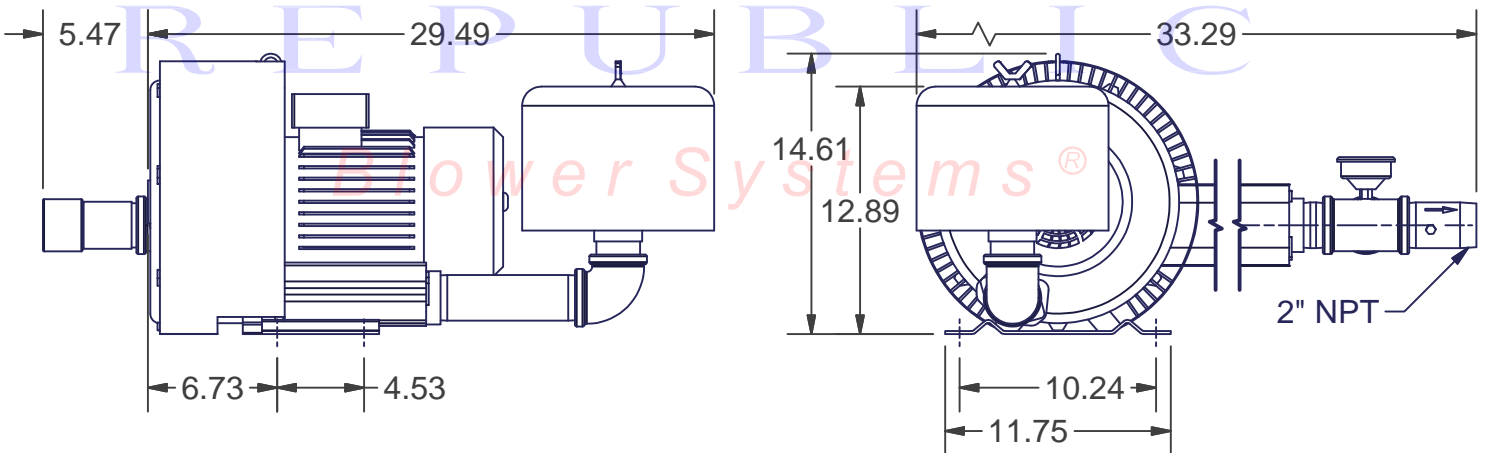

Approx Weight _____

Kit Pressure 2" NPT

KPHRB602